

Alumina 32 dB ATTENUATOR

Features:

- ◆ Alumina
- ◆ DC to 2 GHz
- ◆ 5 Watt Input Power

General Description:

The ABC2010CT-3200JN-93-05 is a 32 dB alumina chip attenuator with a frequency range from DC to 2 GHz. It has an input power of 5 Watts while maintaining a heat sink temperature of 100°C and is solder mountable.

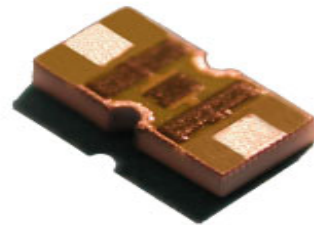
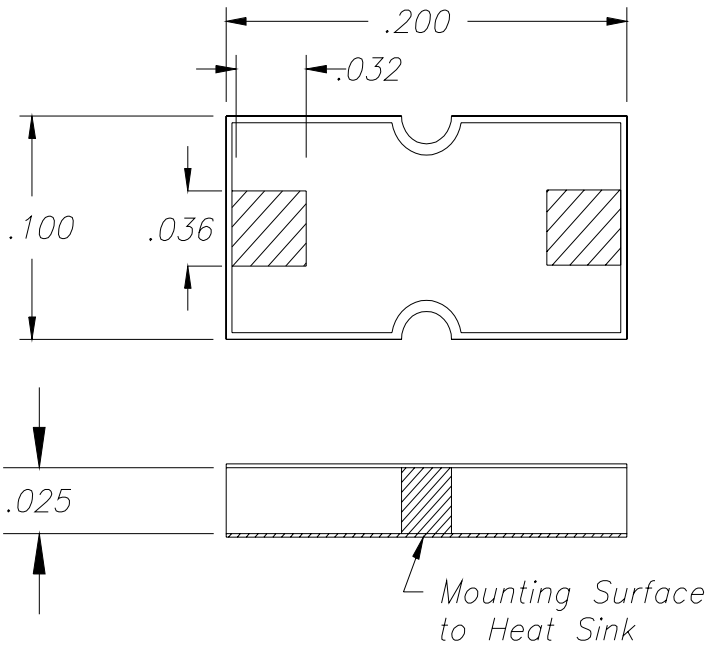

DERATING CURVE:

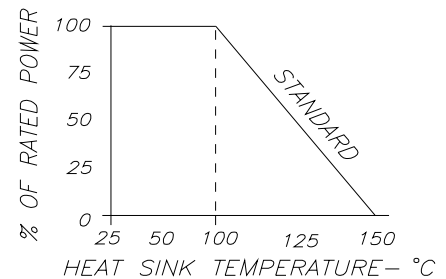

Parameter	Min.	Typ.	Max	Units
Frequency Range	DC		2	GHz
Attenuation	31	32	33	dB
Input Return Loss	25			dB
Output Return Loss	25			dB
Input Power			5	Watts
Mounting Surface Temperature			100	°C

* Barry Industries reserves the right to change part number and or process without notification

Barry Industries, Inc., 60 Walton St., Attleboro, MA 02703 T: 508-226-3350 F: 508-226-3317 E-mail: sales@barryind.com

Barry Industries maintains an ISO 9001 Certified Quality Management System

Origination Date	Revision Date	Rev.
01/30/07	01/30/07	-