

Alumina **20 dB** **CHIP ATTENUATOR**

Features:

- ◆ Alumina
- ◆ DC to 6 GHz
- ◆ 5 Watt Input Power
- ◆ CT - Matte Tin over Nickel over Silver
- ◆ Solder Mountable

General Description:

The ABC2010CT-2000JN-94-11 is a 20 dB Alumina chip attenuator with a frequency range from DC to 6 GHz. It has an input power rating of 5 watts while maintaining a constant mounting surface temperature of 100°C.

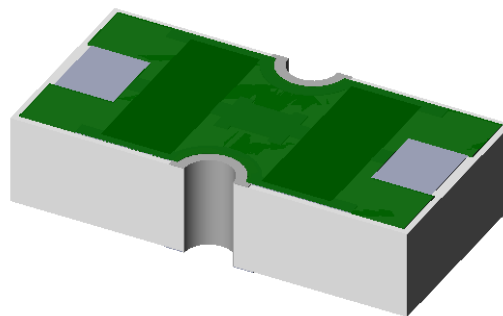
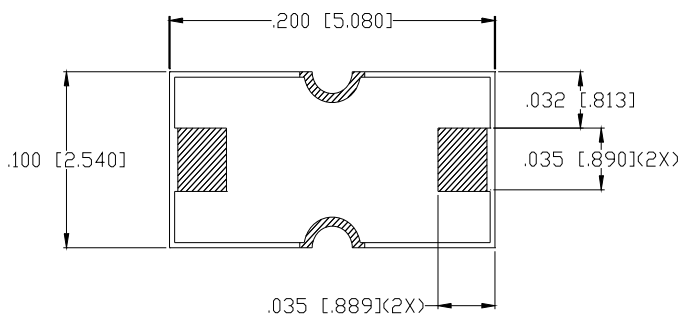

Dimensions in inches [mm]
Tolerance ± .005 [.127]
unless otherwise stated

UNIT MAY BE MOUNTED
IN EITHER DIRECTION

DERATING CURVE:

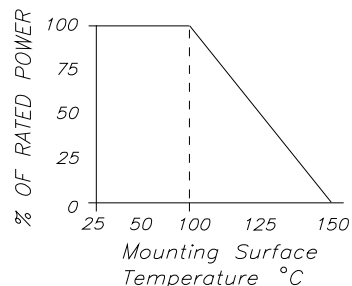

Parameter	Freq. Performance	Min.	Typ.	Max	Units
Frequency Range		DC		6	GHz
Input Power				5	Watts
Attenuation:	DC - 2.0 GHz	19.7	20.0	20.3	dB
	>2.0 - 3.0 GHz	19.7	20.0	20.4	
	>3.0 - 4.0 GHz	19.7	20.0	20.6	
	>4.0 - 5.0 GHz	19.7	20.0	20.8	
	>5.0 - 6.0 GHz	19.7	20.0	21.0	
Input/Output Return Loss:	DC - 2.0 GHz	25.0			dB
	>2.0 - 3.0 GHz	20.0			
	>3.0 - 4.0 GHz	18.0			
	>4.0 - 5.0 GHz	15.0			
	>5.0 - 6.0 GHz	12.0			
Mounting Surface Temperature				100 150 (0% Power)	°C

Barry Industries reserves the right to change part number and or process without notification.

Barry Industries, Inc., 60 Walton St., Attleboro, MA 02703 T: 508-226-3350 F: 508-226-3317 E-mail: sales@barryind.com

Barry Industries maintains an ISO 9001 Certified Quality Management System

Origination Date	Revision Date	Rev.
08/31/11	08/31/11	-