

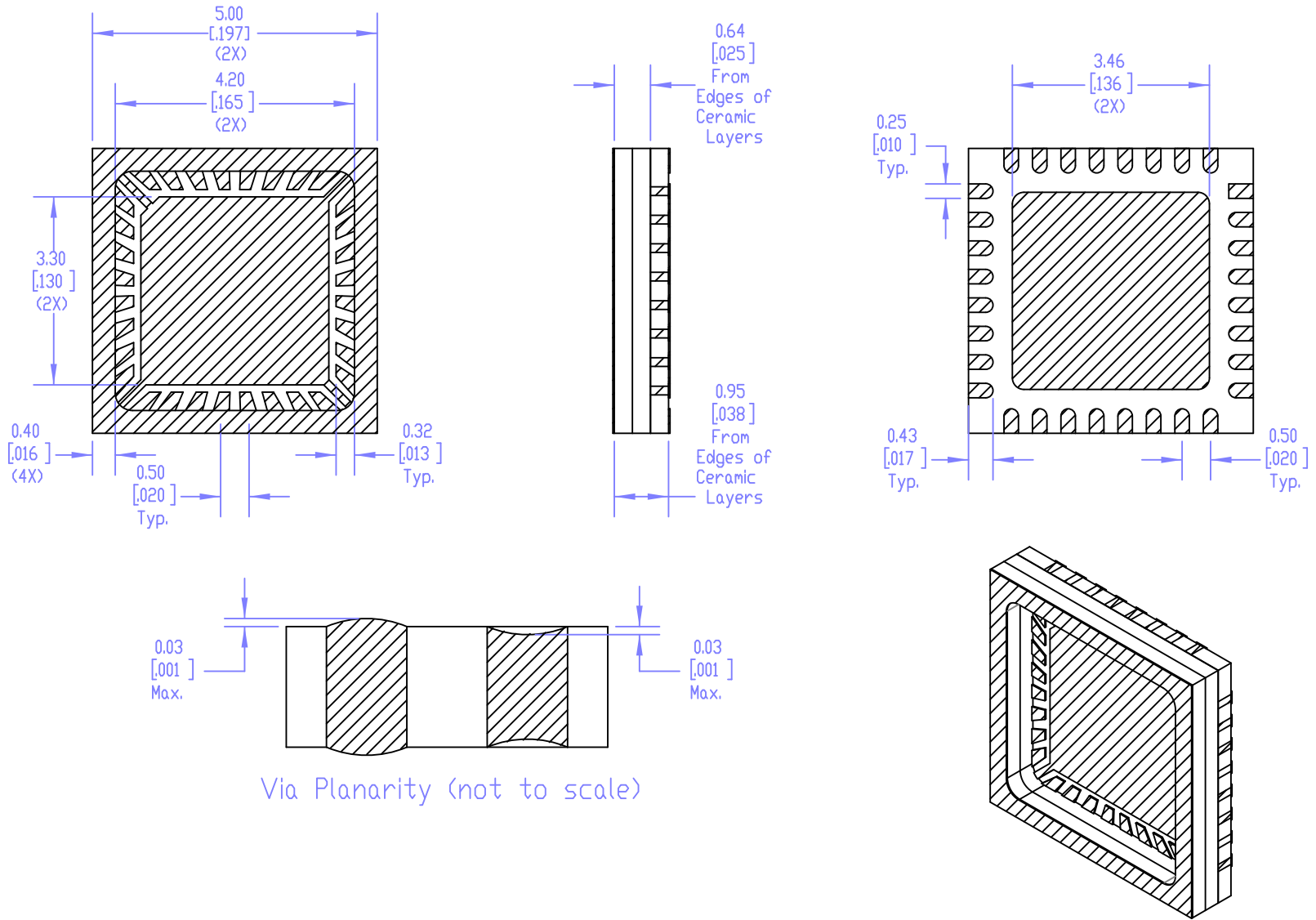

Revisions	ECO #	
	Approved	
	Date	
	Description	
Rev		



Via Planarity (not to scale)

Drawn R. HUOT	Date NOV 9 2016	UNLESS OTHERWISE SPECIFIED: DIMENSIONS ARE IN MILLIMETERS.		 60 WALTON ST. ATTLEBORO, MA. 02703 (508) 226-3350 www.barryind.com	Title 5mm - 32 Pin QFN - Grounded Seal Ring w/ Castellations	
Engineering	Date	TOLERANCES ON DECIMALS	ON ANGLES		Drawing No. QFN-5532-0522	
Q.A.	Date	.X ± .25	± .5°		Revision B	
Manufacturing	Date	.XX ± .10			Material Alumina	Used On
Released	Date	.XXX ± .050		Finish		Qty.
		.XXXX ± .0100	CODE IDENT NO. 6P825		Scale 9:1	
				Drawing Size A		Sheet 1 of 1