



WWW.BARRYIND.COM

ABC2335CT-0200GN-99



BeO 2 dB CHIP ATTENUATOR

Features:

- ◆ BeO Material
- ◆ DC - 4 GHz Performance
- ◆ 150 Watt Input Power
- ◆ CT - Matte Tin over Nickel over Silver
- ◆ Solder Mountable

General Description:

The ABC2335CT-0200GN-99 is a 2 dB, BeO chip attenuator. It has an input power of 150 watts, while maintaining a constant mounting surface temperature of 100°C. It offers a frequency range from DC to 4 GHz.

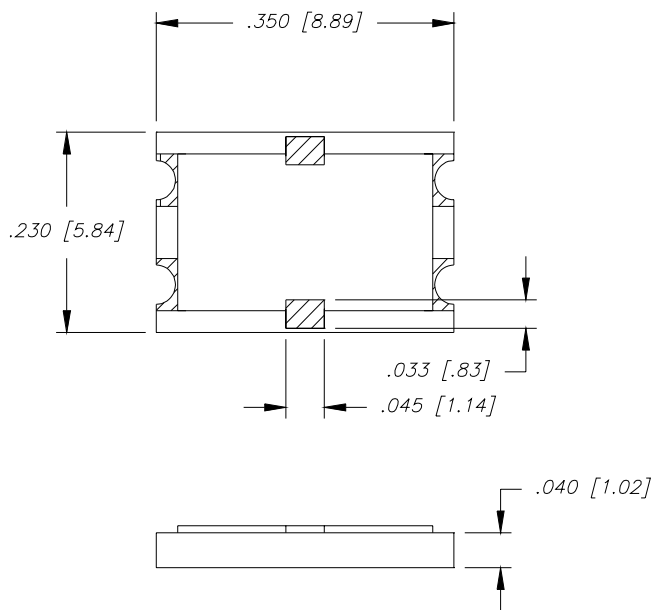

Dimensions in inches
Tolerance $\pm .010$
unless otherwise stated

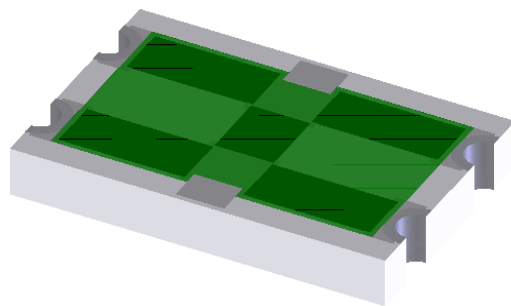

DERATING CURVE:

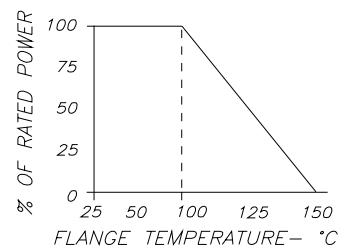

Parameter	Min.	Typ.	Max.	Units
Frequency Range	DC		4	GHz
Input Power			150	Watts
Input Return Loss	20			dB
Output Return Loss	20			dB
Mounting Surface Temperature			100	°C
Attenuation	1	2	3	dB

Barry Industries reserves the right to change part number and or process without notification.

Barry Industries, Inc., 60 Walton St., Attleboro, MA 02703 T: 508-226-3350 F: 508-226-3317 E-mail: sales@barryind.com

Barry is ISO 9001:2000 Certified by



Origination Date	Revision Date	Rev.
07/17/08	07/17/08	-