

ALUMINUM NITRIDE 20 dB LEADED ATTENUATOR

Features:

- ◆ AIN material
- ◆ 100 Watt Input Power
- ◆ Solder Mountable

General Description:

The H05Z-2000J2T-26C36-X is a 20 dB Aluminum Nitride leaded attenuator with a frequency range from DC - 2.5 GHz and an input power of 100 Watts while maintaining a mounting surface temperature of 100°C max.

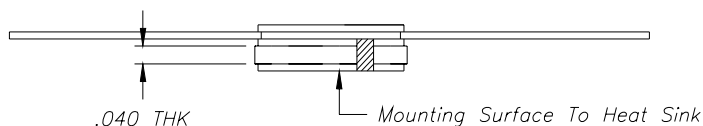
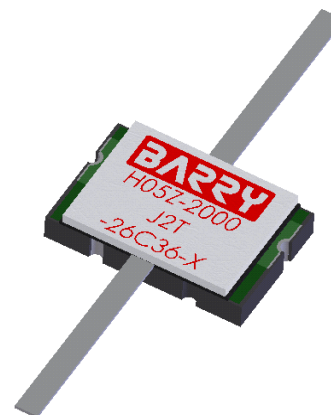
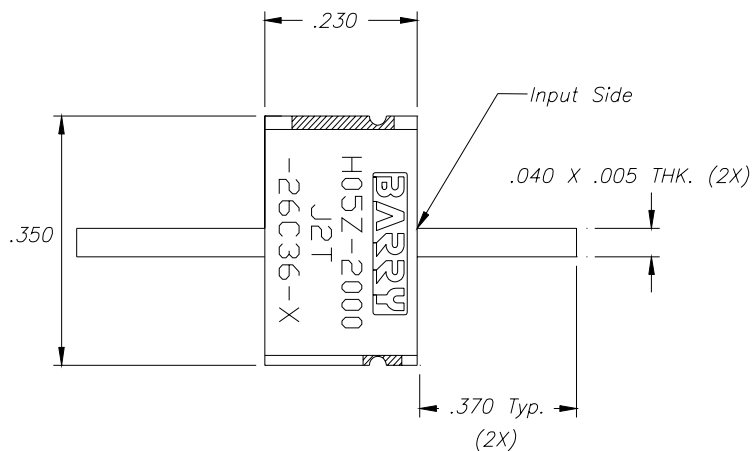

DERATING CURVE:

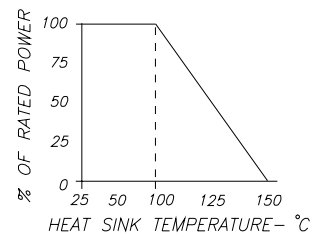

Parameter	Min.	Typ.	Max.	Units
Frequency Range	DC		2.5	GHz
Attenuation	19	20	21	dB
Input Return Loss	25			dB
Output Return Loss	25			dB
Input Power			100	WATTS
Reverse Power (output)			2	WATTS
Mounting Surface Temperature			100	°C

* Barry Industries reserves the right to change part number and or process without notification

Barry Industries, Inc., 60 Walton St., Attleboro, MA 02703 T: 508-226-3350 F: 508-226-3317 E-mail: sales@barryind.com

Barry is ISO 9001:2000 Certified by



Origination Date	Revision Date	Rev.
06/25/07	06/25/07	-